

6.7 IKE 219-4

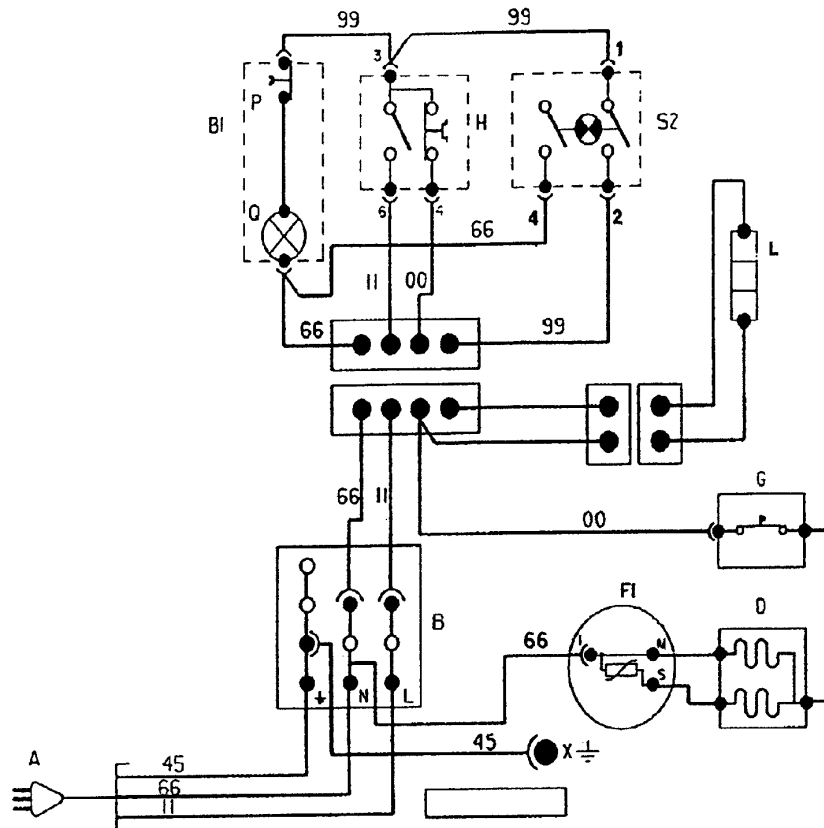

- A Plug
- B Connecting block
- BI Connecting block
- D Compressor - freezer
- FI PTC
- G Motor protection
- H Thermostat
- L Defrosting heater
- P Light button
- Q Lamp
- S2 Switch with pilot lamp (yellow)
- X Compressor earth connection

- 00 black
- 11 brown
- 45 yellow-green
- 66 blue
- 99 white

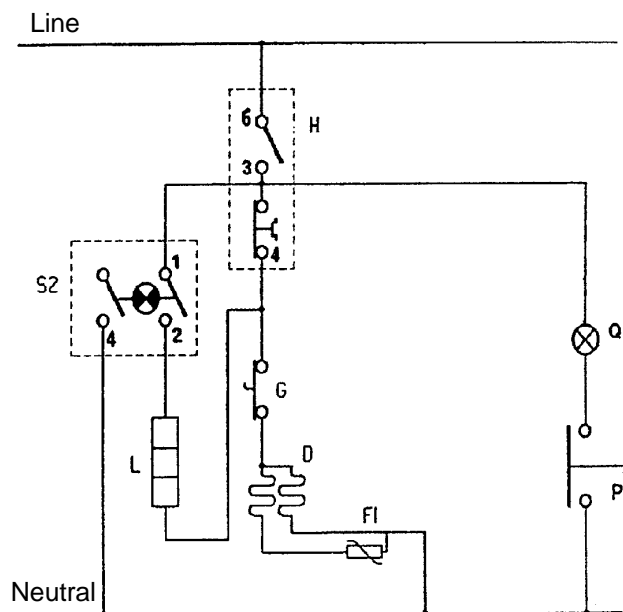

4619 500 85380

Explanation of abbreviations

B 1	Temperature regulator - refrigeration
B 1.1	Switching-off contact (temperature regulator)
B 2	Temperature regulator - freezing
B 2.1	Switching-off contact (temperature regulator)
B 2.2	Signal contact (temperature regulator)
B 3	Electronic thermostat
B 3.1	Thermostat module
B 3.2	Operation and display module
B 4	Fixed thermostat for ambient temperature
E 1	Lighting
E 2	Defrosting heater
E 3	Front frame heater
E 4	Trough heater
E 5	Diaphragm unit heater
E 6	Front plate heater
E 7	Bottom heater
E 8	Winter heater
F 1	Overload protection M 1
F 2	Overload protection M 2
F 3	Thermal cut-out (Light/thermostat combination)
F 4	Thermal cut-out (plinth cabinet)
H 1	Pilot light green
H 2	Pilot light yellow
H 3	Pilot light red
H 4	Acoustic signal (buzzer)
K 1	Starting relay M 1
K 2	Starting relay M 2
K 3	Switchover relay
M 1	Compressor - refrigeration
M 2	Compressor - freezing
M 3	Fan motor
M 4	Radial fan
Q 1	Main switch
R 1	Detector - super circuit (NTC)
R 2	Detector - standard circuit (NTC)
S 1	Light button
S 2	Froster button
S 3	Buzzer switch (temperature increase)
S 4	Buzzer switch (door open)
S 5	Switch for winter heater